

GL-GXL

Li-ion
TECHNOLOGY



The power of the big machines
and the agility of the small ones

 **FIMAP**[®]

GL-GxL

The sturdy and strong structure enables to work everywhere



The GL and GxL scrubbing machines are suitable for small environments in any industry, even the most demanding ones. For this reason, the external body is so robust.

The polyethylene body completely protects mechanical parts, outlining a robust and clean design, which makes easier to move in particularly narrow areas.

GL

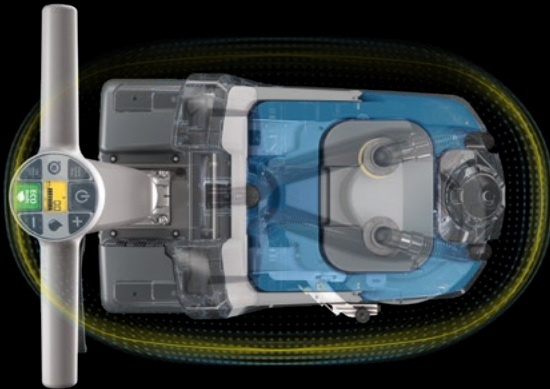

GxL

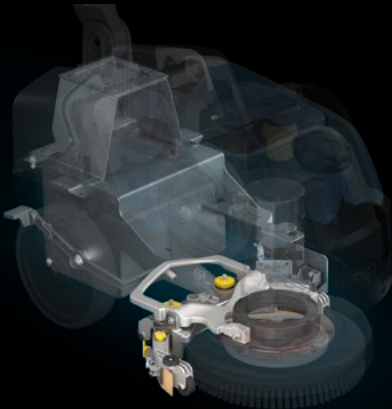
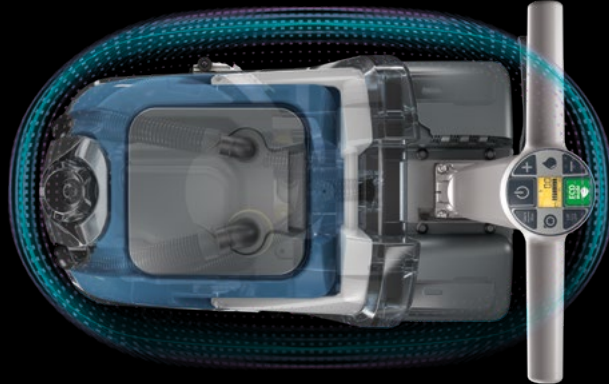

The squeegee is made of aluminum and the frame is covered with a corrosion-resistant coating, so GL and GxL are totally protected against moisture while quality and performance are preserved over time.



GL



Fimap has chosen lithium-ion technology to give you more



Thanks to the lithium battery, you can charge up the machine whenever you want, so it's always ready when you need it. And, compared with a traditional battery, it lasts longer and provides maximum power when you need it. The lithium battery delivers the right power for each application and has excellent endurance

ENERGY CONSUMPTION

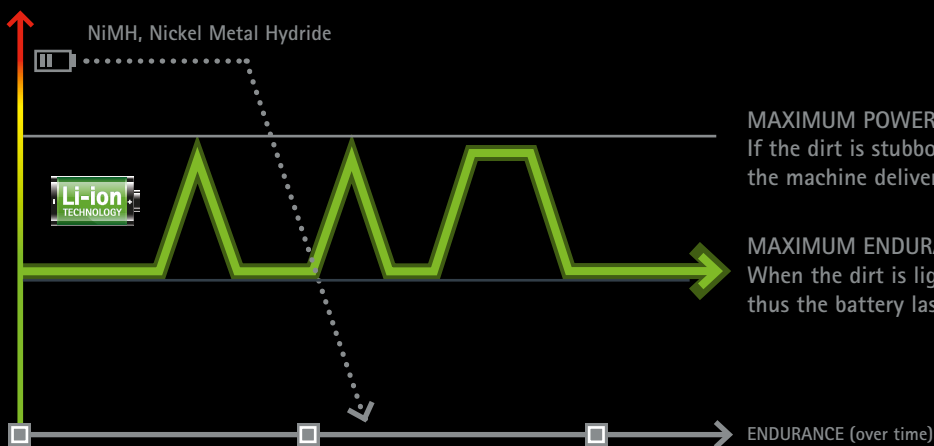

MAXIMUM POWER for dirty floors
If the dirt is stubborn and difficult to remove, the machine delivers more power

MAXIMUM ENDURANCE for light maintenance cleaning
When the dirt is lighter, power returns to normal levels thus the battery lasts longer



MAXIMUM POWER
Increased power only when needed



ALWAYS READY TO USE
No self-discharge, the battery is always ready when you need it. No memory effect, you can recharge the battery whenever you want



MAXIMUM ENDURANCE
Under normal dirt conditions, the power remains constant, increasing battery endurance



QUICK CHARGE
You can use GL and GxL many times in the same day: charging to 80% takes just one hour. Charging to 100% takes 3 hours*



LOW RUNNING AND MAINTENANCE COSTS
High discharge/charge cycle lifespan

* With optional battery charger for Li-ion batteries

GL-GxL

New user experience: just a touch to get started

The small touchscreen enables a quicker and more intuitive use of the machine.
Save time every day: to start a maintenance cleaning shift, just press the Eco mode and go.



GL and GxL can be used anytime and anywhere:
with Eco mode, silence is ensured even in sensitive environments.





P

Handlebars can be adjusted in height and tilt, for a comfortable use. They can be folded down completely for machine easier storage.

Traction versions are switched on with a key



Big wheels increase machine stability and manoeuvrability, both in heavy-duty working conditions and during transport.



GL-GxL

Daily maintenance requires just a few minutes,
thus saving time for additional tasks

Smart solutions speed up maintenance operations

The recovery tank is equipped with a handle to be easily carried during emptying operations, like a common bucket.

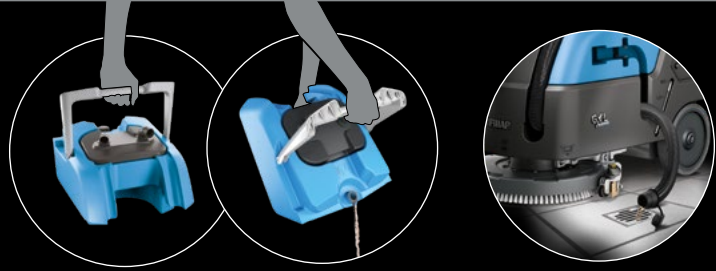

GxL's dirty water tank can be emptied also using a handy lateral tube

GL and GxL can be easily taken apart
to facilitate daily maintenance

RECOVERY TANK

CLEANING
SOLUTION TANK

GL

GxL



Colour code highlights machine parts that need to be cleaned at the end of the shift, so as not to forget any steps of daily maintenance and ensure consistent performance over time.



On-board battery charger

At the end of the shift, with the on-board battery charger, GL and GxL can be charged anywhere, thus avoiding wasting time to return to a specific place.



The access door to the battery compartment is designed to open completely and act as a support: this makes replacement easier and comfortable

GL-GXL

PARABOLIC SQUEEGEE

Perfect scrubbing and drying, in any direction

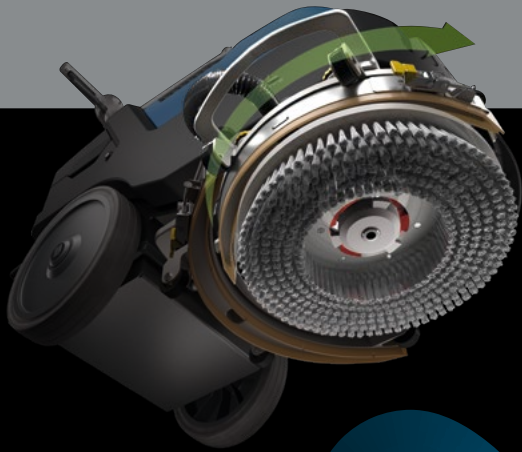

Parabolic
squeegee

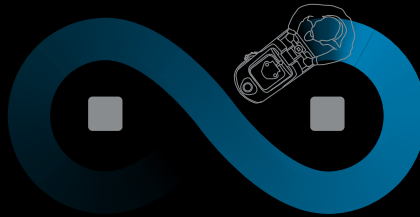

The squeegee is parabolic, it moves along with the machine when making turns or when the path is not straight. So drying is perfect, with no smudges, cleaning is flawless and the floor is immediately safe.

FORWARD AND BACKWARD
CLEANING

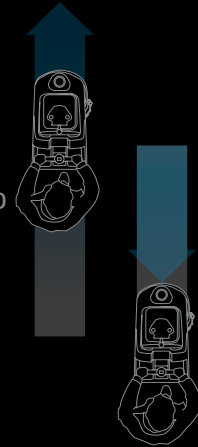

No risk of slipping

The wide suction nozzle of the squeegee and the power of the vacuum motor increase drying performance, thus leaving the floor immediately dry and safe to walk on.



A pump supplies the cleaning solution with a constant flow, which starts from the center of the brush, thus ensuring uniform cleaning even with low amount of water*.

* Disc brush version

Great power for amazing results

GxL

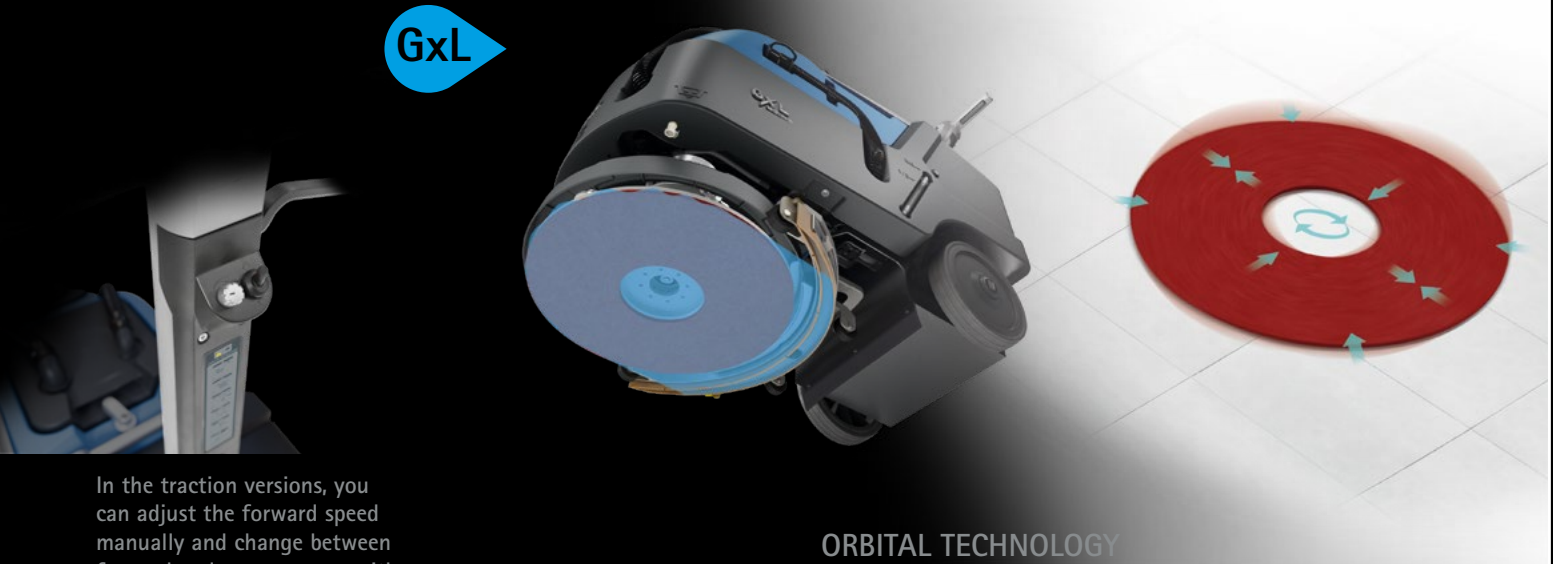

In the traction versions, you can adjust the forward speed manually and change between forward and reverse gears with a lever.

ORBITAL TECHNOLOGY

With the orbital movement, every point of the pad is in constant contact with the floor, ensuring that the cleaning result is always uniform across the entire surface, with reduced energy consumption. The pad action traps the solution and stops it running off at the sides, thereby reducing water consumption.



EFFECTIVE

Uniform cleaning action on the entire surface of the pad



VERSATILE

Depending on the type of associated pad, GxL can perform numerous treatments. It is therefore suitable for a wide variety of applications



COMFORTABLE

Vibrations are reduced to a minimum, thus ensuring greater stability and easy handling



ECO-SUSTAINABLE

The orbital movement reduces the consumption of water, detergent and energy

High brush pressure to easily tackle even the most stubborn dirt on any type of flooring



GL Pro
WITHOUT TRACTION

GxL Pro
WITHOUT TRACTION

GxL Bt Pro
WITH TRACTION



Batteries



(2)
12V - 33 Ah



(1)
24V - 30 Ah



(2)
12V - 55 Ah



(1)
24V - 30 Ah



(1)
24V - 30 Ah



Working autonomy

up to
2 hours

up to
3 hours

up to
3 hours

up to
2 hours



Pressure on the brush

up to
30 kg

up to
40 kg



Brush motor power

440 W

500 W (disc) - **400** W (orbital)



Solution tank

15 l

25 l

Great power for amazing results

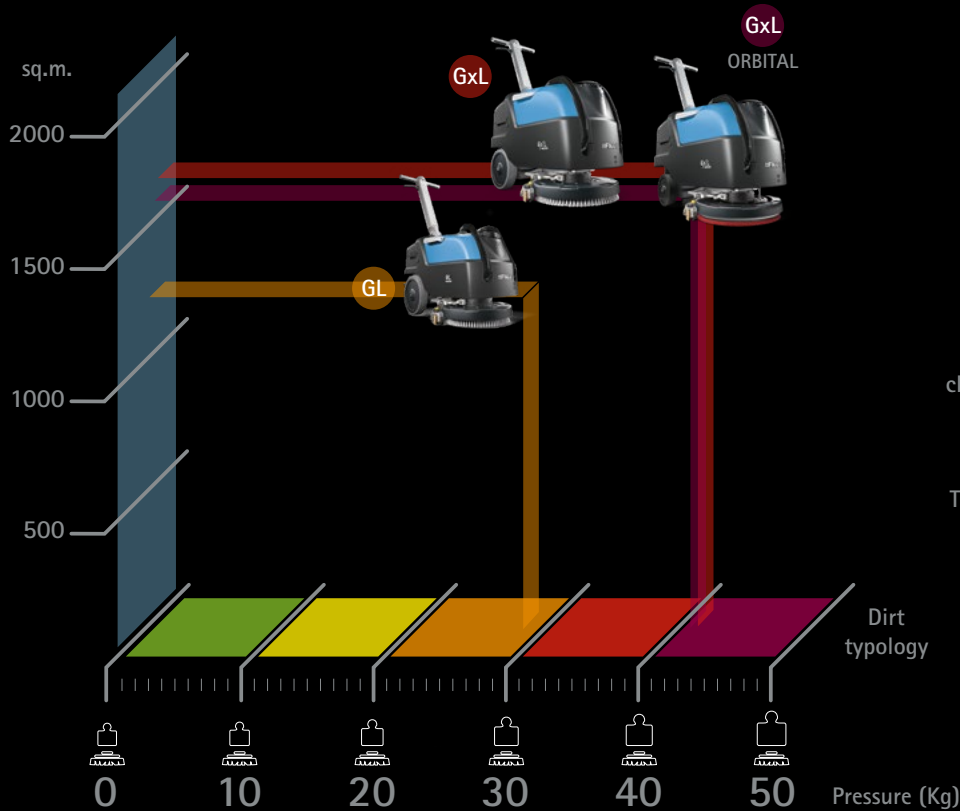

An extraordinary cleaning power where you don't expect it

GL and GxL provide the power and effectiveness of professional cleaning in the tightest passageways in any industry, from the most demanding ones such as healthcare to the most challenging, such as the industrial sector.

They are perfect in spaces between 1000 and 1600 sq.m., to arrive where other scrubbing machines are unable to arrive, and complete the cleaning in supermarkets, warehouses, production sites, car showrooms, workshops, shops, schools, kitchens, canteens and restaurants.

The orbital version of GxL is ideal for heavy-duty treatments.



Operator presence control

When the handlebars are released all machine functions immediately switch off, in order to guarantee safety even in case of sudden stops.



Watch the video



FIMAP FLEET MANAGEMENT



Discover the FFM universe and experience the advantages of being constantly connected, with My.Machine app!

My.Machine app updates you in real time providing all the essential information to help you keep high the fleet performance. You can see from your smartphone or tablet where your machines are, if they're carrying out the cleaning task or if any anomaly occurred. You can see the list of the services

performed, the charger logs and anomalies occurred, in order to have a complete overview of the health status of each machine.

Keep tabs on your machines remotely when you want and from wherever you want!



GEOLOCATION

It shows on a map the machine.



USE INFORMATION

It's possible to know in what working mode the machine is operating and for how long. Moreover, it provides information about the duration of each intervention and the sq.m cleaned.



HEALTH STATUS

Anytime is possible to monitor the health condition of both machines and batteries to have a clear view of the fleet availability and optimize its coordination.



ENVIRONMENTAL IMPACT

All the data related to the CO₂ produced per intervention are available as well as the water and detergent consumption, in order to take action and improve the performance.



ALARMS

The anomalies occurred are summarized in a list which includes a description of the type of issue, and the date and time of the event. It helps you to have an overview of the improper uses that need to be corrected.



BATTERY RECHARGE

It sums up all the complete and opportune recharges performed, the residual charge and the charge settings. This is an essential set of information to extend the battery lifespan and reduce the related costs.



SERVICES

An overview of the list of the maintenance services performed allows to identify discrepancies with the health condition of the machine in case an anomaly is detected, and to monitor the inspections of the whole fleet.

Fimap towards carbon neutrality

CARBON FOOTPRINT SYSTEMATIC APPROACH ISO 14067

GL and GxL are designed according to the principles of the circular economy so they can deliver maximum performance as long as possible and so at the end of their life cycle they can continue generating benefits for the environment.

For this reason, we give value to each phase of their life cycle, making it sustainable and efficient, from when they were produced, while they are being used, up to their disposal.

The life cycle of each machine therefore becomes a virtuous cycle, which we can quantify, using the certified calculation method

CFP – CARBON FOOTPRINT SYSTEMATIC APPROACH,
which communicates the emissions of CO₂e of the individual model, per working hour.

It is a starting point for a path of continuous improvement, which can even arrive to neutralizing its impact on the environment.

TAKE CARE OF THE ENVIRONMENT WITH A BETTER MANAGEMENT OF RESOURCES



The Eco Mode function helps prevent water, detergent and energy consumption by using only the quantities you need and nothing more.



START&STOP

When the machine is idle, the brush motor, the vacuum motor and the water flow will turn off automatically, reducing costs and emissions.



FES-FIMAP ENERGY SAVER
Reduces energy consumption by up to 35%.

1.1 ECO DESIGN

- Selection of materials for durability and recyclability
- Collaboration with suppliers who reflect our values
- ✓ Quality materials that extend the product life cycle
- ✓ Simplification of end-of-life recycling/disposal procedures
- ✓ Protective design that reduces damage and accidents

1.2 MANUFACTURING – 1.3 LOGISTICS

- Industrialization to reduce weights, the variety and complexity of the components, in order to facilitate both assembly as well as disposal
- Packaging optimization: customized and FSC certified boxes for our machines; agreement with suppliers to reuse the packaging up to 20 times
- ✓ Machines easier to maintain, restore and dispose of

2.1. PLANNING

- Planning of cleaning projects in line with environmental requirements of public and private bodies
- ✓ Competitiveness for contracts and tenders
- ✓ Optimization of economic and environmental aspects

2.2 CONFIGURATION – 2.3 USE

- Customized configuration and setting according to specific needs for cleaning and sustainability
- Calculation of the emissions of CO₂e produced by the individual model per working hour
- ✓ Reliability of cleaning interventions, forecast of costs and consumptions
- ✓ Consumption reduction: up to 75% of the water with detergent solution and up to 35% of energy
- ✓ Plan for compensation of the CO₂ emitted, up to 100% for the entire life cycle

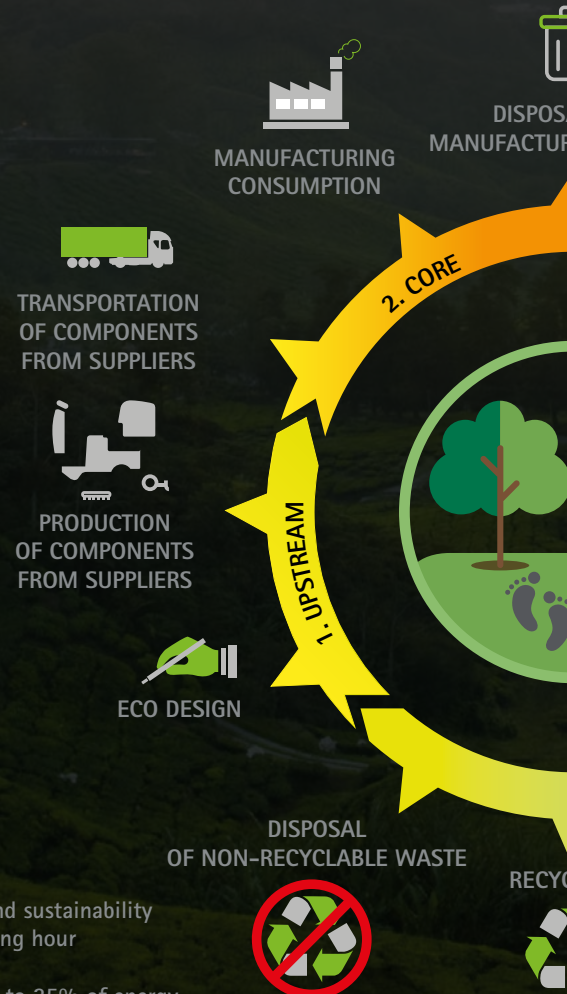



DISPOSAL OF
WASTING WASTE



LOGISTICS



TRANSPORTATION
TO SITE



USE OF RESOURCES



SERVICE

REUSE



RECYCLING



2.4 MONITORING

- Constant remote monitoring of the machines with Fimap Fleet Management
- ✓ Control of consumption, effective use of the machine and the batteries
- ✓ Battery lifespan increased up to 50%
- ✓ Reduction of waste and relative costs due to inefficient use of the machine and the batteries
- ✓ Performance maintained over time

2.5 MAINTENANCE - 2.6 REFURBISHMENT

- Customized maintenance programs according to the application
- ✓ Transformation of variable costs into fixed, lower costs
- ✓ Extension of the product life cycle up to 200%
- ✓ Value of the machine maintained over time

3. 1 RECYCLING - 3.2 DISPOSAL

- High percentage of recyclable material, up to 75%
- Disposal activity simplified by a functional design
- ✓ Reduced disposal costs
- ✓ Material disposal in line with regulations
- ✓ Improvement of the environmental policy

GL-GxL

Configure them as you wish

GL

GxL



VERSION WITHOUT TRACTION

TRACTION VERSION

SINGLE DISC

with 1 disc brush or 1 pad holder

ORBITAL

With pad

BATTERIES



PRO



Version without traction

Membrane control panel

Traction version

OPTIONALS



On board battery charger for AGM/Li-ion batteries



Battery charger for Li-ion batteries (fast charge)



FFM LITE-FIMAP FLEET MANAGEMENT



Antibacterial tanks help inhibit the growth of bacteria and mold

ACCESSORIES

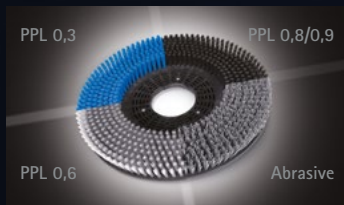

A wide choice of disc brushes in PPL is offered, available in thicknesses from 0.3 to 0.9 cm. These offer the perfect solution for dealing with any type of dirt on any floor.

Abrasive brushes:
Ideal for heavy duty cleaning on industrial surfaces.



Squeegee rubber blades

33 SHORE (PARA)
For maintenance cleaning of smooth floors.

40 SHORE (PARA)
For stubborn dirt on floors with joints.

POLYURETHANE
For heavy duty cleaning on industrial floors, even with wide gaps.



OPTIONAL AND STANDARD EQUIPMENT

USER EXPERIENCE	SINGLE DISC		ORBITAL
	GL Pro	GxL Pro / GxL Bt Pro	GxL Orbital Pro
Membrane control panel	•	•	•
COMFORT			
Hour meter	•	•	•
Cleaning solution level indicator	•	•	•
On board battery charger for AGM/Li-ion batteries	○	○	○
Battery charger for Li-ion batteries (fast charge)	○	○	○
Automatic brush coupling/uncoupling	•	•	-
Noiseless suction	•	•	•
Key switch	-	- / •	•
ON / OFF brush motor	-	- / •	•
PRODUCTIVITY			
Water flow selector	•	•	•
FFM Lite (Fimap Fleet Management)	○	○	○
Squeegee and squeegee support in aluminum	•	•	•
Forward/backward control	-	- / •	•
Speed adjustment	-	- / •	•
SAFETY			
Operator presence control	•	•	•
Antibacterial tanks	○	○	○
ENVIRONMENT			
Eco Mode	•	•	•
FES (Fimap Energy Saver)	•	•	•
Start&Stop	•	•	•

• STANDARD	○ UPON REQUEST	- NOT AVAILABLE
------------	----------------	-----------------

DIMENSIONS AND TECHNICAL DATA

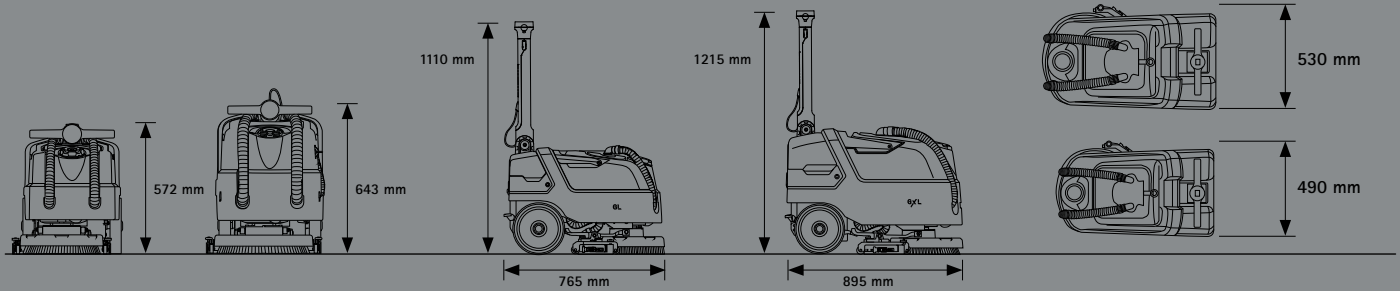

TECHNICAL DATA	SINGLE DISC			ORBITAL	
	GL Pro	GxL Pro	GxL Bt Pro	GxL Orbital Pro	
Productivity theoretical	up to sqm/h	1000	1200	1720	
SCRUBBING SYSTEM					
Working width	mm	355	430		
Brush motor	(no.) V/W	(1) 24/440	(1) 24/500		
Brush rpm	rpm	197	140		
Oscillations	rpm	-	-		
Brush pressure (up to)	kg	30	40		
TANK AND RECOVERY SYSTEM					
Solution tank	l	15	25		
Recovery tank	l	17	27		
Suction motor	V/W	24/280			
Vacuum water lift	mbar	69	68		
BATTERY SYSTEM					
Supply/traction	V	24/semi aut.		24/aut.	
Batteries	(no.) V	(2) 12 (AGM) (1) 24 (LI-ION)		(1) 24 (LI-ION)	
Battery run time*	up to h	2 (AGM) 3 (LI-ION)	3	2	
PROPELLING SYSTEM					
Forward working speed	km/h	2,5		4	
Transport speed	km/h	-		4,6	
Traction motor	V/W	-		24/150	
SPECIFICATIONS					
Machine dimensions (L x h x w)	mm	765 1110 490	895 1215 530		
Squeegee width	mm	440	516		
Machine weight empty without batteries	kg	52,5	68	74,2	70,2
Machine weight empty with batteries	kg	73,5 (AGM)	105 (AGM)	- (LI-ION)	- (LI-ION)
GVW (Gross Vehicle Weight)	kg	84	130	-	-
Sound level (ISO 11201) - Eco Mode	dB (A)	61,4	<70		

* Run times are based on continuous scrubbing run times in Eco Mode

SERVICES

CONSULTING AND PLANNING



We put our experience at your service, to help you realize the cleaning project perfect you. We suggest you the best solutions to make costs decrease and service quality increase.

SETUP



We can help you set up your machines in order to make them meet specifically the requirements of the sites of your project, allowing you to always have control over costs and results.

AUTHORIZED WORKSHOP NETWORK



Fimap Authorized Workshop network spans the globe, so you can enjoy the peace of mind of finding a professional support wherever your business is.

CONFIGURATION



Your business is unique, only a customized fleet can lead you to better results. We will help you find the configurations that best fit the specific requirements of your cleaning sites, in order to optimize processes and lower costs.

TRAINING COURSES



Fimap Academy offers courses for all levels, from the correct use of machines and technologies, up to the management of sites and tenders, helping you to make your service really competitive.

MAINTENANCE AND REPAIR



For your business to run smoothly it is essential that your machines are kept always operational. Our technicians take care of monitoring the machines health status and know how to intervene quickly and effectively when needed.

FINANCIAL SOLUTIONS



You can choose to use the fleet in different ways. We can advise you on the best financial solution for your business, so that you can get the quality of the Fimap world at the most convenient conditions for you.

DIGITAL FLEET MANAGEMENT SYSTEM



With Fimap Fleet Management everything is under your control. You can have a complete overview of the service provided and find out the improvements that can be made, basing your considerations on real data, always available via the MyMachine app or FFM website.

GENUINE SPARE PARTS



Get the most out of your machines, choose the reliability of Fimap original spare parts. They are designed together with the machines, so they perfectly fit them thus guaranteeing the highest quality of performance.

CERTIFICATIONS



For any additional information or for a demo please contact your usual Fimap dealer



FIMAP spa - Via Invalidi del Lavoro, 1 - 37059 S. Maria di Zevio - Verona - Italy - Tel. +39 045 6060411 - Fax +39 045 6060417 - E-mail: contact@fimap.com



Fimap Spa reserves the right, at any time, to make technical and/or equipment modifications without prior notification. The data related to tank liters are indicative of their total volume. The images are shown as reference only and are not binding as to the actual design and/or equipment - Copyright © Fimap 2020 - COD. 302692 - AF - 07-2023